

MAY 1976

# HEWLETT-PACKARD JOURNAL





# New CRT Terminal Has Magnetic Tape Storage for Expanded Capability

*Two built-in tape drives make the terminal a stand-alone data station. User benefits are reduced on-line time costs, lower line charges in remote operations, and greatly lessened demand on computer resources.*

by Robert G. Nordman, Richard L. Smith, and Louis A. Witkin

**M**ANY OPERATIONS NORMALLY requiring connection to a computer can be performed on a stand-alone basis by a new HP CRT terminal, Model 2644A (Fig. 1). Two built-in magnetic tape drives, using the newly developed 3M DC-100 mini-cartridge, provide 220,000 bytes of data storage, enough for a normal day's work at the keyboard.

The new terminal is a logical extension of the HP 2640A Terminal<sup>1</sup>, the first CRT terminal developed by HP and the first of a family of terminals. The 2644A was conceived as a terminal that would be less dependent upon the resources of the host computer and would be capable of significant data entry and text preparation applications totally without the aid of a supporting processor.

For text preparation, the 2644A combines the text editing capabilities of the 2640A with the storage capabilities of cartridge tape. The result is a product that allows the user to prepare, modify, and merge text in any manner independent of computer interaction. The addition of a printer under the control of the terminal allows the user to obtain a hard copy of the text at any stage in its development.

Data entry is another application that has typically been the province of terminals requiring computer support. In general, a form is provided for the user at the terminal from the computer. The user then enters the data into the computer and it is subsequently printed on preprinted forms by the computer's line printer. With a 2644A Terminal in this application, the need for the computer disappears. Forms previously prepared on the terminal and stored on cartridges may be retrieved at the push of a button. The data is entered into the form, and may then either be printed directly or stored on a cartridge to be printed or displayed at a later time. The new terminal is compatible with most serial-interface printers.

The 2644A Terminal has all the capabilities of the

earlier 2640A, and compatibility is assured by retaining the same control codes for the same functions. The 12.7-by-25.4-cm display has a capacity of 1920 characters in a 24-line-by-80-column format. A 9×15-dot character cell shows large characters accurately, removes ambiguity, and relieves operator fatigue. Inverse video (black on white), blinking, half-bright, and underlining may be employed in all possible combinations.

The 2644A can display multiple character sets. A 128-character Roman set, including lower case and displayable control characters, can be used along with as many as three additional character sets. Available are a math-symbol set, a line drawing set that can be used to generate the user's data entry forms



**Cover:** Model 2644A Terminal is a microprocessor-controlled CRT terminal that has two built-in magnetic tape units for mass data storage. The tape units accept the new 3M Company DC-100 mini-cartridge.

## In this Issue:

*New CRT Terminal Has Magnetic Tape Storage for Expanded Capability*, by Robert G. Nordman, Richard L. Smith, and Louis A. Witkin **page 2**

*Mini Data Cartridge: A Convincing Alternative for Low-Cost, Removable Storage*, by Alan J. Richards, **page 6**.

*Laboratory Notebook—A Logarithmic Counter* ..... **page 16**





**Fig. 1.** Model 2644A Terminal has all the features of the 2640A plus 220 kilobytes of mass data storage provided by two built-in mini-cartridge tape units.

on the display, and a Cyrillic character set.

Like the 2640A, the new 2644A has an RS232C communications interface and can transfer data from semiconductor memory or cartridge tape at rates up to 2400 baud (9600 baud on binary output).

**Keyboard Layout**

The 2644A Terminal has the same keys as the 2640A, plus four new keys (see Fig. 2). Two of the new keys are prefix keys that alter the functions of one or more other keys. To minimize confusion, the altered function is printed next to a key in the same color as the prefix key. There is a gold prefix key for device selection functions and a green prefix key for

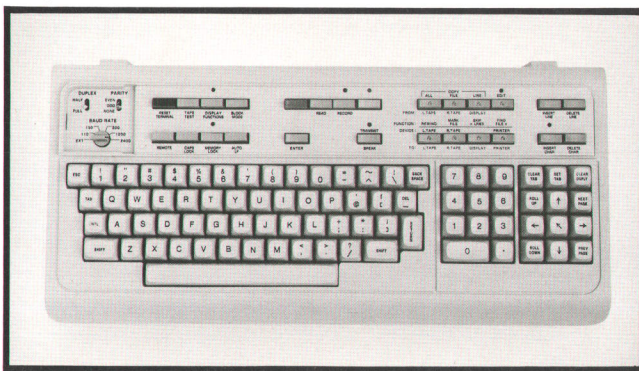

**Fig. 2.** READ, RECORD, and two prefix keys control cartridge tape operations. The prefix keys alter the functions of the special function keys f1-f8.

data transfer and device control functions. The other two new keys are for the READ and RECORD functions.

The 2644A has been designed to provide different levels of sophistication and flexibility for the user. On the most basic level, the READ and RECORD keys allow the user to transfer data between the cartridges and the display when in local mode, or between the cartridges and the computer when in remote mode. Operating the terminal in this manner is no more complicated than operating a teleprinter with a paper tape reader and punch. For example, pressing the READ key when in remote mode causes the terminal to transfer records of information from the cartridge to the computer until an entire file has been sent.

A user operating on this level may retrieve any of eight files directly from a cartridge to the display and record the contents of the display onto a cartridge by pressing the ENTER key. For example, assume that file 5 on a cartridge is a form previously generated on the display and stored on the cartridge. If the f5 key is pressed in local mode, file 5 will be located on the cartridge and the form will be transferred from the cartridge to the display. The terminal may now be placed into format mode and data may be entered into the unprotected fields. When the information has been verified by the user, pressing ENTER will record the contents of the unprotected fields onto a second cartridge.

The next level of capability for the user allows data to be transferred between the display, cartridges, and



printer in any direction. The amount of data that is transferred is determined by the user and may be either a "line", a "file", or "all".\* The terminal has the ability to bring data from one cartridge into the bottom of the display memory, allow the user to change the data in any manner, and record the modified text and any overflow from the display onto another cartridge; this capability is available in the EDIT mode.

The user can change at any time the specification of the device that data is coming from, called the FROM device, and the device(s) that data is going to, called the TO device(s). These device selections apply to any data transfer operation involving the display, the cartridges, and the printer. When the terminal is first turned on or reset, the left cartridge is automatically assigned as the FROM device and the right cartridge as the TO device.

The highest level of sophistication provided to the user is extensive control of the cartridge tapes and printer. The cartridge may be rewound, records may be skipped in either a forward or reverse direction, files may be located either by specifying their absolute file number or their position relative to the present file location, and file marks may be recorded on the tape to separate one file from the next. The printer paper may be spaced a given number of lines or moved to the top of the next page. To illustrate, assume that the right cartridge contains data from a form, and the user wishes to transfer the data from file 23 on the cartridge to a preprinted form on the printer. He first locates file 23 on the cartridge by pressing the green key followed by FIND FILE n, 23, R. TAPE. Next, the user specifies the right cartridge as the FROM device and the printer as the TO device, then presses the green key and COPY FILE. This transfers the data to the preprinted form with exactly the same spacing as on the display.

### Cartridge Tape System Design

Design objectives for the cartridge tape system for the 2644A Terminal emphasized low cost, reliability, and flexibility. Specifically, the mechanism had to be designed for mass production using low-cost manufacturing techniques. To meet the interchangeability and error rate goals, the cartridge location with respect to the magnetic head had to be accurate and positive under extreme environmental conditions. The tape units were to require no field adjustments. Important subassemblies had to be modular and mechanical assembly time and electrical wiring minimized. Power requirements had to conform to standard voltages and levels available in most instrument power supplies. Reliability and life had to represent a contribution compared to existing cassette

and paper tape peripherals; a maximum of one transferred error in  $10^8$  bytes under typical instrument conditions was a minimum goal. Finally, as much control as possible was to be implemented in firmware, thereby reducing costly hardware and increasing flexibility.

Fig. 3 is an overall block diagram of the electronic portion of the cartridge tape system. The mechanical portion, the drive mechanism for the mini-cartridges, is described separately in the box on pages 12 and 13.

The requirements of standard voltages and minimum system current drain dictated the choice of a motor and operating speed. Fast access to any portion of the tape is important, but access speed is necessarily limited by the available power. Desirable motor characteristics, therefore, are efficiency and the ability to accelerate and decelerate rapidly. An "inside-out" or hollow-rotor permanent-magnet dc motor was chosen because of its low inertia and high efficiency. The motor's commutator has precious metal brushes with extended life coating. Life testing has shown the average lifetime of these motors to be greater than 2000 operating hours. They permit a rewind or fast forward tape speed of 60 inches per second.

Read/write speed was determined by the ability of the processor to handle the data rate. Recording density is 800 bits per inch and read/write speed is 10 inches per second, giving a data rate of 125 microseconds per bit or 1000 bytes per second, a rate compatible with available microprocessors. The tape mechanism itself is capable of a read/write speed of about 30 inches per second and a data rate of 24 kHz, the limit established by adequate head-to-tape contact.

The data density of 800 bpi was chosen as the optimum phase-encoded density attainable with the mini-cartridge in view of the error-rate goal. This density is equivalent to 100 bytes per inch unformatted or 168,000 bytes per track. This is more than enough capacity for a paper tape replacement application, so it was decided to optimize reliability by changing from the usual 0.050-0.060-inch two-track format to a full-width single-track format. This doubles the system signal-to-noise ratio and reduces susceptibility to errors caused by debris.

### Recording Format

Information is stored serially on the tape. Fig. 4 shows the recording format. Data is organized into files, records, bytes, and bits. Files may be an entire user program or a logical subset of a program such as a page. Files are directly addressable by the user and are searched for at fast speed by the terminal. Separating the files are file marks, special-length gaps (areas of unidirectional magnetization) with a file identification record between them.

Each line of data on the CRT is recorded on the tape

\*"Line" = line of CRT data. "File" = entire file. "All" = entire contents of cartridge. Also see Fig. 4.



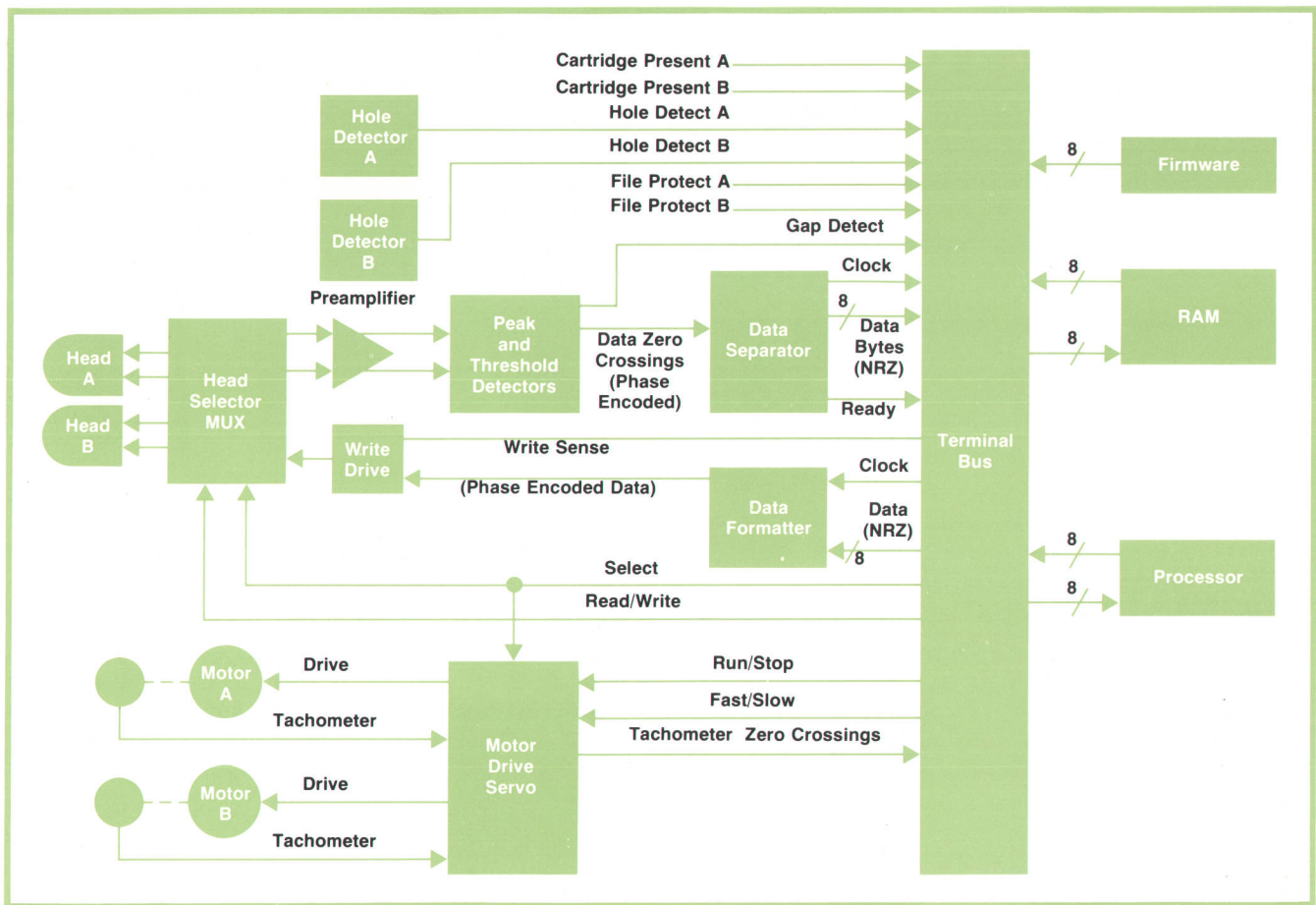

Fig. 3. 2644A cartridge tape system is a combination of hardware and firmware. Most control functions are implemented in firmware.

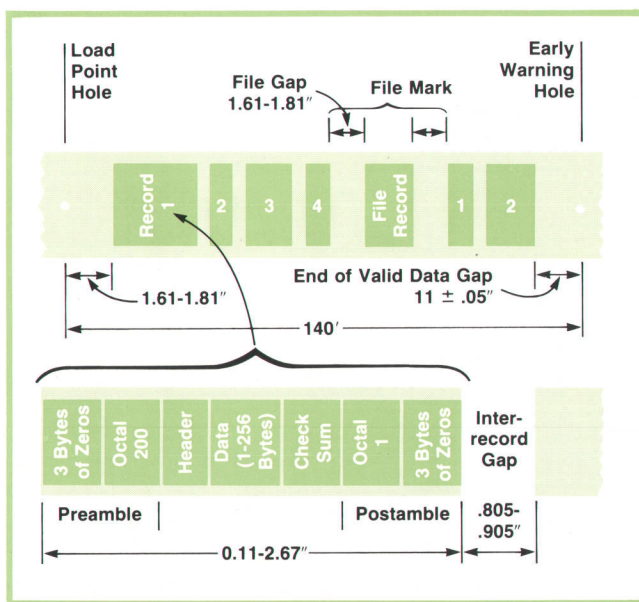

Fig. 4. 2644A tape format detail. Data is formatted into records separated by gaps. Each record consists of preamble, header, body (one to 256 bytes of data), checksum, and postamble. The user may further organize the data into files identified by file marks.

as a record. Each record consists of a preamble, a header, 1-256 bytes of data, a checksum, and a postamble. The preamble, consisting of three bytes (1 byte = 8 bits) of zeros and one byte of octal 200, is used in a phase-lock loop to synchronize the internal decoder clock with the data rate, and to alert the system that data follows. The header is two bytes long and tells the system how many data bytes are in the body of the record. In the body, each byte represents either an ASCII character as seen on the CRT, a special control character for blinking, half-bright, line drawings, or other display enhancements, or in some cases simply binary data. The checksum is a single error-checking byte that represents a binary addition of all the data bytes. If an error is detected the system rereads that record. The postamble, a mirror image of the preamble, is used to synchronize the decoder when data is being read in reverse.

#### Recording Code

The choice of code was influenced by the amount of flutter or short-term speed variations expected in the cartridge. A self-clocking phase-encoding technique

Continued on page 7.



# Mini Data Cartridge: A Convincing Alternative for Low-Cost, Removable Storage

by Alan J. Richards

Calculator Products Division

Many small, low-cost digital systems need an inexpensive, nonvolatile, removable memory medium. Devices that have been employed by such systems include punched paper tape, punched cards, magnetic cards, Philips-type cassettes, and 3M DC-300 data cartridges. Each of these has limitations. Punched paper tape and cards are bulky and slow. Magnetic cards, if small enough to be convenient, have a limited capacity (on the order of one kilobyte). The cassette generally has a low performance/cost ratio; most systems employing the cassette settle for low capacity and low transfer and access rates, or are expensive and bulky. The DC-300 data cartridge boasts a higher performance/cost ratio, but for many applications (a small desk-top calculator, for example), it takes up an excessive amount of panel space.

## An Alternative

The new 3M DC-100 mini-cartridge employed in the 9815A and 9825A Calculators and in the 2644A Terminal offers a new alternative (Fig. 1). The cartridge is convenient; it fits nicely in a

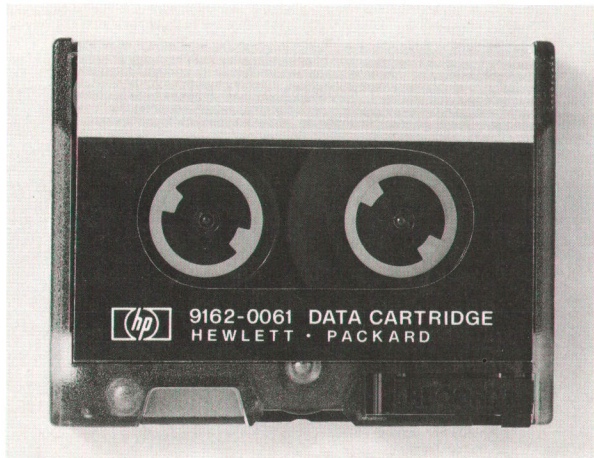

Fig. 1. New mini data cartridge measures only 63.5 mm  $\times$  82.5 mm  $\times$  12.7 mm (2.5 in  $\times$  3.25 in  $\times$  0.5 in).

shirt pocket, and requires only 0.5 $\times$ 3.2 in of panel space. The cartridge is driven at a single point, making possible a simple, low-cost drive mechanism with one motor. Mechanically, a drive for the cartridge can be very reliable because it is so simple.

The mini-cartridge has good data reliability. Tape handling is gentle because all motion is controlled by the elastomer belt and the tape always passes over the same precision guides. This makes it nearly impossible to stretch or damage the tape during start, stop, or direction reversal. A tape capstan or pinch roller is not required, eliminating many related problems such as dirt pressed into the tape and tape damaged by being wound up on the pinch roller. When the cartridge is removed from the drive, a door covers the tape at the head access point, leaving the tape well protected. Finally the mini-cartridge has a small plastic scraper that removes large dirt particles as the tape passes over it.

The mini-cartridge is designed for high performance in a low-cost tape system. Speeds up to 90 inches per second make short access times and fast transfer rates possible (rewind at 90

ips takes 19 seconds). Acceleration rates up to 2000 inches/second<sup>2</sup> help to keep start/stop distances to a minimum. As much as 5.4 megabits of unformatted data can be stored on the 140 feet of 0.150-in-wide tape, assuming a recording density of 1600 bits per inch on two tracks. Extensive tests have demonstrated an error rate of less than one error in  $2 \times 10^8$  bits.\* The system in which the cartridge is performing has a large influence on what error rate is visible to the user, of course; write verification and automatic re-read improve the apparent error rate while misuse and contamination tend to degrade it.

For a more quantitative indication of the performance contribution, we can compare the cartridge system in the new 9825A Calculator to the cassette system in the earlier 9821A Calculator. The access rate is 30 times higher for the 9825A; access rate is the number of bytes passing the head per second at search speed. Cartridge capacity is four times greater. Yet the manufacturing cost for the tape system in the 9825A is just over one-half that for the 9821A.

## History of Development

Early in the development of HP's third generation of desktop calculators, the potential of a small DC-300-like cartridge was recognized. The DC-300 was scaled down and prototypes were built to show feasibility. HP then met with 3M Company, holder of the patent on the DC-300 data cartridge. 3M recognized the potential for this cartridge and agreed to help develop it and to manufacture it for HP. Since that time it has been a cooperative effort to refine the concept, prepare for volume production, and solve problems as they came up.

## How It Works

The cartridge is driven at the surface of the drive pulley (see Fig. 2). This pulley drives the elastomer belt, which in turn drives

\*In these tests an error was counted each time a data bit read from the tape differed from what was recorded on the tape, regardless of whether the error could have been corrected by re-reading.

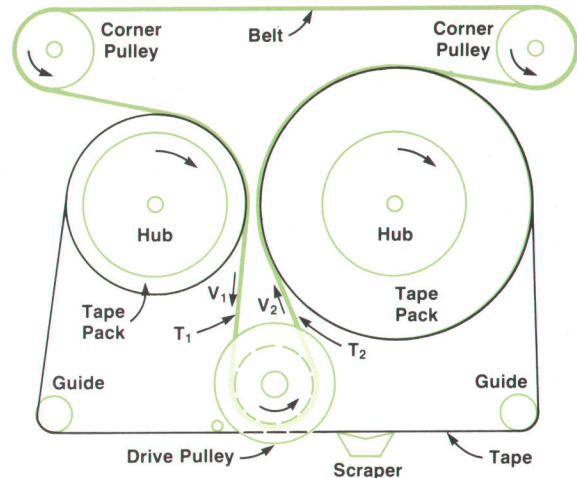

Fig. 2. An elastomer belt drives the tape and both reels. Only one drive motor is needed and there is no tape capstan or pinch roller.



both packs of tape. The belt actually drives the outermost turn of tape, not the tape hub; this results in constant tape speed independent of the sizes of the two packs, at least to a first approximation.

What happens if slack develops in the tape? If the tape velocity were the same at both packs, the slack could not be removed, and tape tension would be lost. To understand why this does not occur, refer again to Fig. 2. Imagine that the tape is not connected between the two packs; this is essentially the case if slack develops. The cartridge then simplifies to a drive pulley driving an elastic belt which in turn drives four more pulleys. Friction in the pulley bearings causes a force that opposes this movement. This tension "drop" at each pulley will cause belt tension  $T_1$  to be greater than tension  $T_2$ . Per unit mass, the belt will be longer where the tension is higher. Since in the steady state the belt cannot be accumulating anywhere, belt velocity  $V_1$  must be higher than velocity  $V_2$ , because a greater length of belt must pass a given point to have equal mass flow. Therefore, one tape pack, always the take-up pack, tends to have a higher surface velocity. When the two packs are connected by the tape and any slack is removed, they are forced to have the same surface velocity; the mechanism just described then serves to maintain tension in the tape.

From the above discussion, it should be apparent that the belt is the heart of the cartridge. It drives the tape with constant speed, it tensions the tape and prevents slack buildup, and it makes possible the single-point drive.

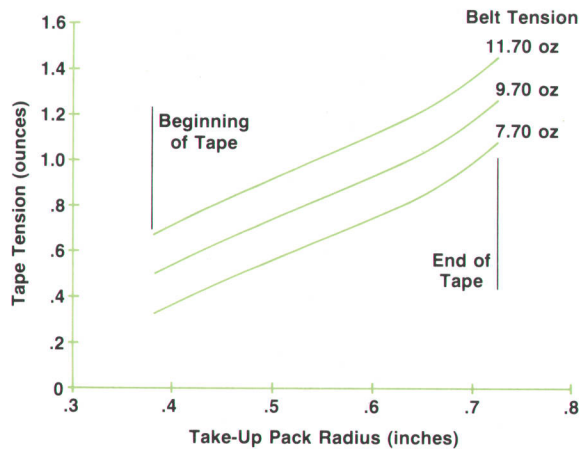

**Fig. 3.** An HP 9821A Calculator helped develop the mini-cartridge by solving nine simultaneous equations and producing plots like this one.

#### Cartridge Model

One tool used extensively in the development of the cartridge was a mathematical description of cartridge steady-state operation. This model consists of nine equations in nine unknowns. The nine unknowns are the forces in the system; five are tensions in each of five members of the belt, three are tape tensions, and one is the drive force. Of the nine equations, five express the sum of moments about each of the five pulleys; two

express the sum of forces at the two tape guides; one is a constraint on the five belt tensions; and the last, which is deduced from the fact that the surface velocity of the two tape packs is the same, expresses equality between two belt tensions.

This system of equations was programmed on a 9821A Calculator with a peripheral 9862A Plotter. Input to the calculator consists of the physical dimensions of the cartridge, the coefficients of friction for the bearings and guides, and the tension and elasticity of the belt. Output consists of belt and tape tensions, and the drive force. Fig. 3 is a typical output plot, showing the relationships among tape tension, position in the pack, and belt tension.

#### Design Challenges

Cartridge development was not without challenges, of course. One challenge was getting long life from the cartridge. Problems with the interface between the tape and the two fixed tape guides were responsible for premature cartridge data errors. Guides that were too rough caused wear to the tape and resulted in increased drive force and excess debris. Smooth guides, on the other hand, caused the tape to adhere to the guides, resulting in high drive force and high-frequency tape speed variations. The life problem was solved by tightly controlling the guide surface finish and using a tape with an improved, tougher backing.

Another problem was caused by severe thermal or mechanical shock. The outer portion of the tape pack would slip toward the base plate or the cover, frequently resulting in a jammed cartridge. It was found that the undesirable pack looseness always developed within 0.075 in of the tape hub. The solution consisted of adding flanges to the hubs that were slightly larger than this to contain the tape.

A final challenge was loss of tape-to-head contact caused by low tape tension. Average tape tension could be increased by several methods—increasing belt tension or increasing coefficient of friction, for example—but this would increase friction between guides and tape and reduce cartridge life. Another approach was finally taken. The tape tension has an ac component caused in part by out-of-round pulleys. By holding a tighter tolerance on the roundness of the three pulleys, minimum tension was increased without sacrificing life.

#### Acknowledgments

Perry Pierce was responsible for much of the design of the cartridge, including making the early prototypes that were taken to 3M, and development of the mathematical model. Much refinement was done by Bill Boles and Hoyle Curtis, and by Bob Nordman at HP's Data Terminals Division. Much of the interaction with 3M was handled by project managers Chuck McAfee and Ed Muns, and by Bob Colpitts at HP's Data Systems Division. Ken Heun, Don DiTommaso and, at Data Terminals Division, Rich Smith, Curt Gowan, Bill Ulrey, and Frank Goodrich performed extensive testing and evaluation. Barry Mathis was responsible for cartridge esthetic details. Other persons involved in some phase of the project include Max Davis, Greg Vogel, John Becker, Rich Kochis, Norm Carlson, Cheryl Katen, Bill Hein, and Ron Griffin. The author wishes also to express appreciation to Robert von Behren, Bob Wolff, Gary Moeller, Sten Gerfast, Les Collins, and Ron Stimpson of 3M Company whose cooperation made this joint venture possible.

called biphasic level was judged optimum (see Fig. 5). Cell boundaries established by the synchronized internal clock occur at a nominal 125-microsecond in-

terval. Positive-going flux reversals between cell boundaries are decoded as logical ones and negative-going reversals as logical zeros. Since each cell con-



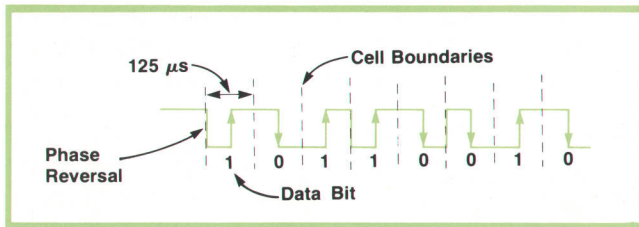

Fig. 5. Data is recorded using biphas level code.

tains a data bit, the internal clock can be kept in synchronism with the actual data rate.

The power spectrum of the encoded data is zero at zero frequency, has a peak below the frequency represented by a nominal period of 125 μs, or 8 kHz, and has no components above 16 kHz. Thus the decoder circuit can have relatively narrow bandwidth, which results in a better signal-to-noise ratio than would be possible using other codes such as NRZI.

### Tape Motion Control

Precise control of tape motion is the key to the low error rate of the 2644A. Fig. 6 is a block diagram of the speed control servo system. In the mini-cartridge, tape motion is transferred from the belt capstan to the tape through an elastic band. It is important that the belt capstan be driven with constant acceleration and deceleration so as not to excite the natural resonance of the belt-tape system and lose instantaneous tape tension. Speed control is equally

important so that a constant density is written on the tape. Many motor speed detection schemes were explored, including dc tachometers, optical encoders, and back-emf sensing. Since low cost was a primary objective and measurement of distance as well as velocity a required feature, a variable reluctance tachometer was designed. An inexpensive toothed wheel is staked to the drive capstan assembly to act as a return path for a dc magnet. Changes in flux are sensed by a simple coil in the magnetic path. The geometric design of the wheel teeth results in a sinusoidal tachometer output. Zero crossings of the tachometer signal are detected and sent to the servo for speed control and to the controller for distance measurement.

The servo converts the tachometer zero crossings into constant-width pulses and integrates the result to obtain a velocity signal. For a tape velocity of 10 ips the motor turns at approximately 12 revolutions per second. There are 48 teeth on the tachometer disc, and the tachometer output frequency is 584 Hz. The resulting closed loop bandwidth of the servo system is approximately 70 Hz. Phase margin is 45°.

Commands to the servo (fast, slow, forward, reverse) go to a ramp generator that limits tape acceleration and deceleration to 400 in/s<sup>2</sup>. There are two servo drive amplifiers, one for each tape drive, so high-current switching is avoided. Current feedback assures constant drive torque.

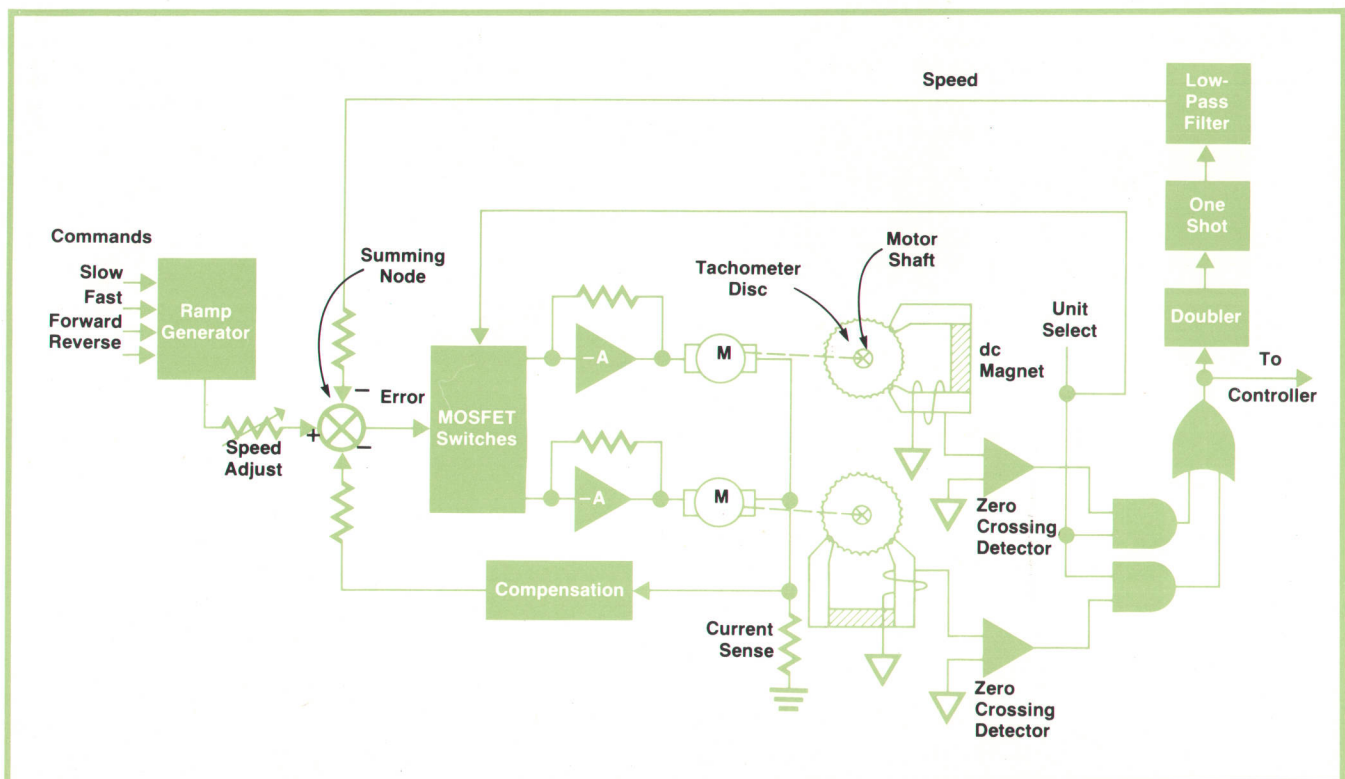
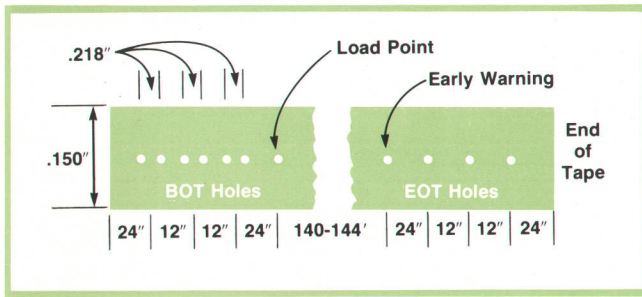

Fig. 6. Servo system controls tape motion precisely, contributing to the terminal's low error rate.





**Fig. 7.** Holes in the tape identify the beginning of the tape, the load point, the early warning point, and the end of the tape and prevent catastrophic failures such as tape unspooling.

### Hole Detection

Reliability means not only low error rates but also freedom from catastrophic failures such as tape unspooling. To distinguish the beginning of the tape from the end, two holes 0.026 inch wide are punched 0.218 inch apart in three pairs 12 inches apart. At the end of the tape three single 0.026-in holes are punched 12 inches apart (see Fig. 7). The controller determines which hole is being detected.

Reliable sensing of these holes is a problem in itself. Light enters the cartridge through a window in the base, is reflected by a mirror, passes through the tape hole, if present, and goes out the front to a detector. To increase reliability, an infrared light-emitting diode is used as a source and a silicon phototransistor is used as the detector. To increase instantaneous light output without exceeding average-power limits, the LED is pulsed with a low duty cycle. The light pulses picked up by the detector are amplified and

fed to a retriggerable one-shot multivibrator. As long as pulses are being received the one-shot output remains high, thereby acting as a digital integrator.

### Read/Write Electronics

The read/write circuits (Fig. 8) accept the phase-encoded data from the encoder/decoder circuit, record this data on tape, read the tape, and reconstruct and deliver the phase-encoded data back to the encoder/decoder circuit.

The read/write head has its center-tap connected to a transistorized current source that provides write current to the head when requested by the RECORD ENABLE control. Controlling the current source with a voltage ramp minimizes the danger of recording transients on the tape when power is turned on or off. The write drivers are part of the unit/function decoder, which also contains all the logic required to select between the two tape units and between the write and read modes. The states of the decoder inputs determine which unit is active and the mode of operation. A head current sensing circuit provides the RECORD-IN-PROGRESS status signal to the interface.

A CMOS quad bilateral switch isolates the preamplifier from the write circuitry during write operations and, together with the unit/function decoder, connects the selected head to the preamplifier during read operations. The preamplifier is a differential-input/output IC operational amplifier. The differential connection reduces environmental noise and eliminates the need for shielded head leads. Following the preamplifier is the differentiator, also a differential-input/output IC op-amp, which converts the preamp peaks to zero crossings. The zero

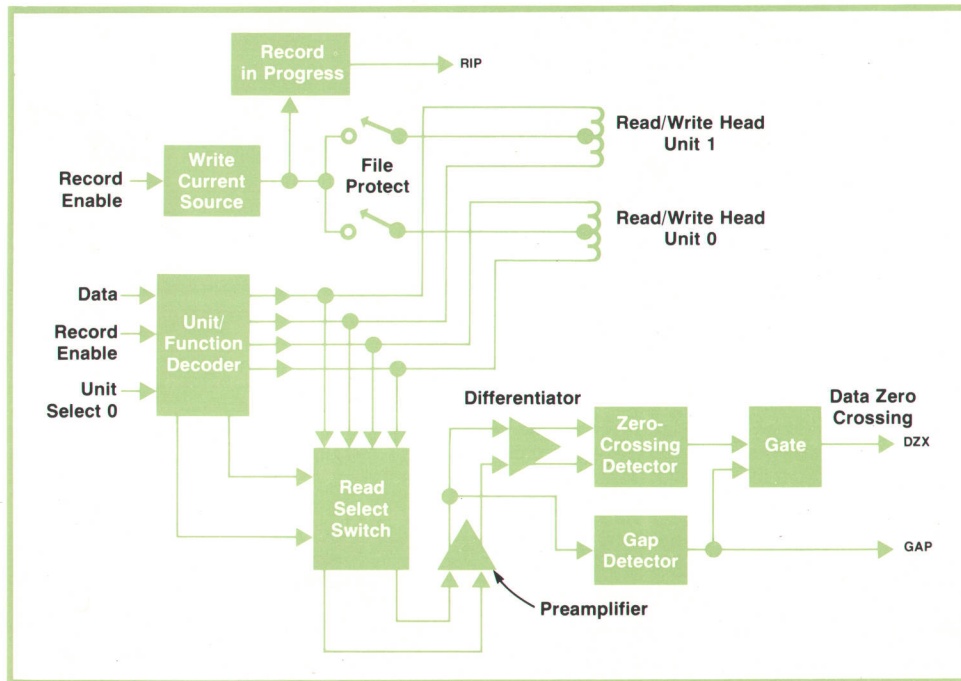

**Fig. 8.** 2644A read/write electronics.



crossings, which represent flux transitions, are detected by a comparator. The digital output of the zero-crossing detector is delivered to the encoder/decoder circuit.

The in-phase output of the preamplifier is also applied to another comparator, operated as a threshold detector. To eliminate ambient noise, the threshold is set at 15% of the nominal amplified head output. Following the threshold detector is an integrator circuit driving a Schmitt trigger. This combined circuit comprises the gap detector. Nominally, about one millisecond is required after starting to read data for the integrator capacitor to attain the level that will turn on the Schmitt trigger. The same time is needed to allow the capacitor to discharge to the level that will turn off the Schmitt trigger after the end of data. Thus this circuit effectively distinguishes between inter-record gaps and data dropouts and between data blocks and random noise pulses.

The data zero crossings from the zero crossing detector are inverted through another Schmitt trigger and applied to one input of an OR gate with GAP as the other input. This arrangement quiets the output of the zero crossing detector during inter-record gaps.

### Encoder/Decoder

The encoder changes NRZ (non-return to zero level) data into phase-encoded serial data for recording on the tape. The decoder does the converse. Two major requirements for the decoder were that it be low in cost and that it be able to reliably separate data and clock phase transitions in spite of the relatively unstable time base that results from system speed variations. Time-base instability is overcome by a digital phase-lock loop that is synchronized with the data rate actually coming from the tape. The decoder tolerates any tape speed between 6 ips and 16.6 ips and phase errors caused by jitter, flutter, and pulse crowding of  $\pm(25\% \mp 100\%/N)$  of one data cell, where  $N$ , the variable modulus of a counter, is nominally 77. Fig. 9 is a diagram of the encoder/decoder.

The encoder/decoder data shift register exchanges data with the terminal bus by means of an 8-bit data buffer and a "byte ready" status bit. To encode the byte in the data shift register into phase-encoded data, the encoder is set to the complement of the data shift register output at clock transition time. Then at data transition time, the encoder is complemented, the data in the shift register is right-shifted, and the bit counter is incremented. The "record gap" signal sets the encoder to record an inter-record gap.

Encoder timing is provided by the cell-decode and variable modulus counters. In record mode the up-down counter section of the variable modulus counter is set to the two's complement of 77. The frequency of  $C_{IN}$ , the output of the binary up counter, is equal

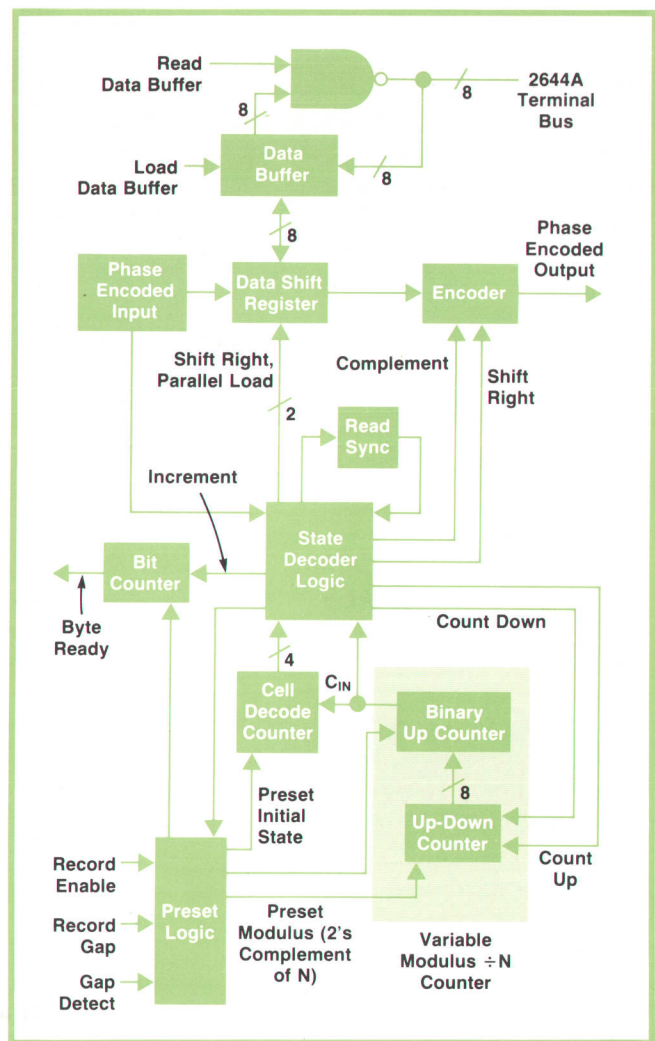

Fig. 9. An all-digital encoder/decoder tolerates large frequency and phase shift errors, assuring interchangeability of cartridges.

to the system clock frequency divided by the counter modulus  $N$ , or in this case  $4.9150 \text{ MHz} \div 77 = 64 \text{ kHz}$ . The cell-decode counter counts  $C_{IN}$ , beginning at state 6, counting to state 13, and then resetting to state 6. States 9 and 13 are decoded with  $C_{IN}$  to give the clock and data transition times, respectively. Note that  $8 \times 10 \text{ ips} \times 800 \text{ bpi}$  is  $64 \text{ kHz}$ , so eight states of the cell-decode counter have a period equal to that of the nominal data frequency,  $8 \text{ kHz}$ .

Decoding is accomplished by detecting the direction of the data transition that occurs in a time window beginning at  $1/4$  cell time and ending at  $3/4$  cell time. The window is shifted on each transition to reflect the actual data frequency from the tape. During the inter-record gap preceding each record, the up-down counter section of the variable modulus counter is set to the two's complement of 77. When the "gap detect" signal goes low the cell-decode counter is incremented with  $C_{IN}$ . Initially,  $C_{IN}$  has a fre-



quency of 64 kHz. The cell-decode counter counts from state 6 to state 15 or until a biphasic level transition occurs. States 8, 9, 10, and 11 are decoded as the clock transition zone and states 12, 13, 14, and 15 are decoded as the data transition zone. Since four states of the cell-decode counter correspond to 50% of a cell, this places a window of  $\pm 25\%$  of a cell period around the expected positions of the clock and data transitions. If a transition does not occur in the center of the window the frequency of  $C_{IN}$  is changed by changing  $N$ , the modulus of the variable modulus counter.  $N$  is increased by decrementing the up-down counter and vice versa. This is done for each transition in the preamble. At the end of the preamble the frequency of  $C_{IN}$  reflects the actual data rate from the tape; it is equal to  $(4.9150 \text{ MHz})/N$ , where  $29 < N < 106$ .

During the record body, decoder operation is similar except that a clock transition does not reset the cell-decode counter. A transition in the data zone increments the bit counter and shifts the biphasic level input into the data shift register. This continues until the next gap is detected.

#### **Cartridge Tape Firmware**

Responsibility for cartridge tape operations is divided between the cartridge tape hardware and firmware. The hardware maintains constant speed and provides for selection of fast or slow speed and the direction of tape motion. If a hole is detected in the tape, indicating tape location, tape motion is stopped until the firmware commands it to start again. The hardware encodes and decodes data bytes into bit patterns on the tape and records interrecord gaps. The hardware reacts to commands given by the firmware and presents status information to the firmware.

The firmware is responsible for controlling all tape motion and maintaining tape-position information. The firmware dictates whether the hardware is reading, recording, or writing gaps. It formats data into records and generates special tape marks that have significance in organizing the tape into records and files. The firmware can scan the tape at slow speed for reading or recording data or at high speed for file search. The firmware enforces boundary conditions prescribed by the tape format or the logical functioning of tape operations.

Tape operations are controlled by firmware drivers. There are two levels of drivers for each type of operation, physical drivers and logical drivers.

The physical drivers interact directly with the hardware to accomplish a specific objective. They can read a record from the tape, write a record, write a file mark, write an end-of-data mark, rewind the tape to the beginning-of-tape (BOT) mark, locate the load point, skip forward or backward over records, and

find file marks at high speed. Only one drive may be running at any time, so the microcode for the drivers is minimized by making their operation independent of which drive is operating. The pertinent variables for each drive, such as tape position, are maintained in an area of random-access memory (RAM) and are swapped whenever the opposite drive is selected.

Logical drivers are responsible for handling the parameters that are passed to the physical drivers from the input/output (I/O) control firmware. These parameters include the drive to be selected, the number of iterations, and the direction of tape motion. A logical driver detects the presence of boundary conditions such as the end-of-data mark, the load point, and early warning holes to determine the premature termination of an operation. Attempts to perform illegal operations, such as recording on a tape that is write-protected, are rejected and control is returned to the I/O control firmware for further action.

The I/O control firmware has two responsibilities: controlling the transfer of data between devices, namely the cartridge tape units, the display, and the printer, and performing control functions for specific devices, including acquiring the current status of any device.

Data transfer operations are performed by the I/O control firmware by repetitively calling the appropriate logical drivers for the devices involved until the requested amount of data is transferred, an error is encountered, or the operation is interrupted by the user. If an error occurs and the user had initiated the operation, then the proper error message is selected and displayed until the user acknowledges that he has seen the message. The I/O control firmware also calls logical drivers to reposition the tape (rewinding, skipping over records, finding files), to record file marks or to provide status information.

#### **External Control of I/O Devices**

When the 2644A Terminal is operating under the control of a computer or other controller, the computer can control the I/O devices connected to the terminal (e.g. cartridge tape units or printer). The computer can exchange data with the terminal I/O devices, cause data transfer between terminal I/O devices, and remotely control the I/O devices. It can also acquire status information from the I/O devices.

A problem that had to be resolved is the speed differential between the I/O devices and the communications link from the terminal to the computer. For example, the cartridge tape drives nominally transfer data at a rate of 1000 characters per second, but the communications link operates at rates between 10 and 240 characters per second. Similarly, the terminal might be connected to a printer that processes

Continued on page 13.



## Mini-Cartridge Drive Mechanism

The major problem in the design of the mini-cartridge tape drives for the 2640 terminal family was fitting two drives into a small irregularly shaped volume at the front of the terminal. These cramped quarters with their clipper-ship-bow shape soon became known by the project team as "the fo'c'sle." In addition to fitting into this unlikely space, the drives had to retain the cartridge positively in register with respect to the magnetic head, be comprised of modular field-replaceable subassemblies, have no field adjustments and, of course, cost almost nothing to build.

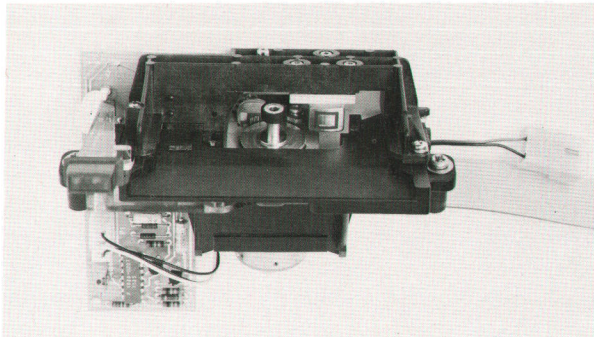

The mini-cartridge drive which evolved from this set of design goals consists of a single major assembly that fastens to the terminal mainframe with two captive screws. A signal cable and a motor cable connect each drive to the read/write servo board. A special bezel covering the front of the terminal mainframe has openings for each drive. Spring loaded doors on the openings for the cartridges provide finish for the unit and protection for the drives.

Three major subassemblies make up the drive assembly: the base assembly, the head bridge assembly, and the motor assembly (see drawing). Each subassembly is designed to be separately replaceable without special tools or adjustments.

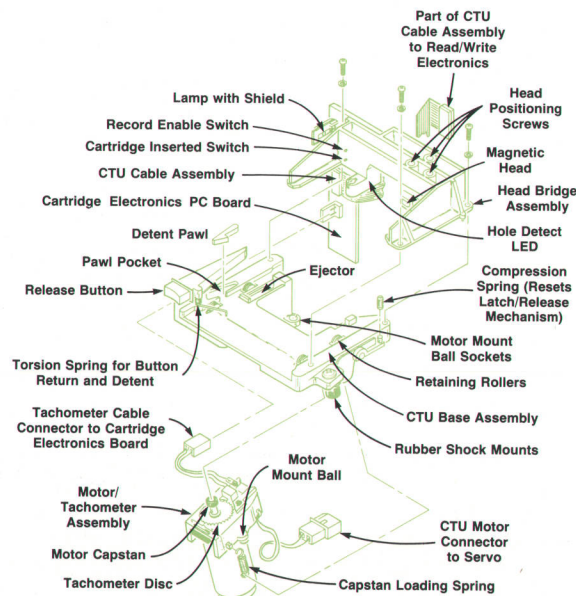

Cartridge tape unit transport assembly, exploded view.

### Base Assembly

The base assembly provides the support structure for the drive and includes two rubber enclosed mounting nuts. These nuts, with associated screws, provide convenient captive fasteners. More importantly, they attenuate mechanical vibrations in the 1-kHz region and above. Without this attenuation, sharp impacts to the terminal could cause read or write errors. A third mounting surface, faced with a rubber pad, is used for location and stabilization of the drive.

To prevent loss of intimate tape/head contact because of insufficient wrap, and to minimize head and tape wear because of excessive wrap, the base assembly has registration surfaces that control the fore and aft position of the cartridge. These surfaces are accurate within  $\pm 0.001$  inch with respect to locating-pin holes on the base. These holes, in turn, determine the position of the head bridge assembly. Side to side location of the cartridge, a less critical registration, is accomplished by maintaining minimum clearance between the cartridge and the drive.

The base assembly also includes a latching and release mechanism actuated by a release button. This button is made of green transparent plastic and acts as a light pipe for light from an indicator lamp on a circuit board at the rear of the drive. This eliminates the cost and complexity of a separate indicator on the bezel. The cartridge is inserted by pushing it in against the spring-loaded latch mechanism. Pressing the button releases the latch, allowing the cartridge to pop out to a detent position for easy removal. The cartridge is ejected part of the way by the motor assembly's swinging forward. At this point the ejector rises out of the base and continues pushing the cartridge out to the detent position. With this arrangement, the ejection force does not oppose the latching force when the cartridge is fully inserted. The mechanism resets itself during ejection and is then ready to accept a cartridge again. The detent action is effected by a pawl that is spring loaded against the cartridge by the same spring that returns the release button.

### Head Bridge Assembly

The head bridge assembly has three pads that contact three small areas on the reference surface of the cartridge. This defines a reference plane for both the cartridge and the drive. The magnetic head is adjusted for tilt and azimuth with respect to this plane as part of the manufacturing process. The read/write head has a ball socket that engages a spherical bump molded into the plastic head bridge. The socket is centered on the magnetic gap in the head, so the tilt and azimuth adjustments are independent of each other. The vertical head position is controlled by maintaining close tolerances on the head and head bridge, so no height adjustment is required. The position of the spherical bump is also held within  $\pm 0.001$  inch with respect to locating pins molded into the head bridge. This accurately controls the fore and aft position of the head to maintain the proper tape/head wrap angle. Once set, the head adjusting screws are sealed in position and no further head adjustment is required either at initial assembly or during field replacement. Thus any head bridge assembly works with any base assembly.

The head bridge assembly includes the cartridge electronics board. On this board are circuits for sensing the position holes in the tape. The infrared LED light source for this function is precisely positioned by a molded-in clamp, taking advantage of the strength and dimensional stability of the plastic material used in the head bridge to grip the LED without additional parts or machining. Cartridge insertion and the position of the record-enable slide



on the cartridge are sensed by the position of two switches. Fixed contact pads for these switches are on the circuit board, while the movable contacts with their plunger actuators are enclosed within the head bridge; this makes for inexpensive, reliable, enclosed switches.

The indicator lamp previously mentioned is also on this circuit board, and is enclosed by a part molded of titanium-dioxide-filled plastic for maximum reflectivity. This part serves the dual function of blocking stray light from the lamp while concentrating the light entering the light-pipe portion of the release button. Since all interconnections are made on the board, no wiring harness is necessary on the mechanism.

#### **Motor Assembly**

The third subassembly, the motor assembly, consists of a motor with drive capstan, a motor mount, and a tachometer to provide velocity feedback to the servo. The entire assembly is single-axis gimballed about its center of gravity to eliminate acceleration effects on the force between the motor capstan and the belt capstan in the cartridge. The gimbal consists simply of two hemispherical ball-and-socket joints between the motor assembly and the base assembly. The assemblies are held together by two extension springs that also provide the correct capstan force. The right-hand ball-and-socket set prevents translation, while the left-hand set has an elongated socket to prevent rotation about two axes without binding. Although this gimbal works well in normal operation, a drop test in the shipping container unseated the ball joints. An extra rib on the head bridge prevents this malfunction, another victory for those troublesome but essential environmental tests.

Besides retaining the motor assembly in its gimbal, the two extension springs load the motor capstan against its mating belt

capstan within the cartridge. This spring loading compensates for an accumulation of dimensional tolerances in the cartridge and the drive while holding the force between the capstans within specified limits. When the tape is not moving, the continuous force between the capstans soon puts a dent in a typical elastomer capstan material. If this dent were to remain when the drive moved tape, the resultant change in tape speed could cause data errors. A special method for testing the recovery properties of the elastomer was developed as part of the extensive investigation to select the optimum capstan material.

#### **Production Processes**

To meet the stringent cost goals for the drive, we decided to avoid expensive secondary machining operations on parts. As a result, only two tapped holes are machined in the aluminum core of the motor capstan, the diameter of the elastomer coating of the capstan is ground to size, and two holes are drilled in the aluminum motor mount. Otherwise, all parts are used as they are produced by the primary fabrication tooling with only a cadmium-plated finish required on the steel parts. The major plastic parts are molded from polycarbonate resin filled with glass and TFE. The strength and dimensional stability of the glass-filled polycarbonate resin allow the close tolerances on the base and head bridge to be held in the molding operation. The TFE reduces friction and wear.

Part costs are held down and consistent quality assured by use of other automatic processes besides plastic molding. The motor mount is an investment casting. The tachometer magnet and pole pieces are pressed and sintered powdered metal. Fine blanking is used to produce the tachometer disc. The plastic retaining rollers and the aluminum capstan core are automatic screw machine parts.

characters at a lower rate than the communications link. This problem is resolved by buffering the data within the terminal. Data is loaded into a buffer before being transferred to its ultimate destination. This allows multiple destination devices to be specified for a data transfer. The data is kept in the buffer until all specified destination devices have received it.

#### **Self-Test**

An important consideration in the definition of any product is how to determine whether it is operating properly. The 2640A Terminal can perform a self-test operation that checks the terminal read-only memory (ROM), the RAM, and the display subsystem. This has been expanded in the 2644A Terminal to include a self-test for the cartridge tape units. When the green key is pressed, followed by the TAPE TEST key, a worst-case data pattern is recorded on the left cartridge tape, the tape is backspaced over the record, the record is read and verified, and a file mark is recorded. Then two standard 2640A self-tests are performed, followed by a test sequence on the right cartridge tape and another standard self-test. This operation provides a go/no-go test of the terminal's performance.

#### **Worst-Case Design and Testing**

Throughout the electrical and mechanical design

process almost every design decision involved conflicts between the realities of commercial component tolerances and the requirements of product reliability. These conflicts were resolved through tolerance analysis and extensive testing.

While less conservative statistical techniques are available, we chose to sum the worst-case errors caused by tolerances, wear, and environment in determining safety margins. For example, low system error rate requires proper tape-to-head contact, which is determined by the wrap angle of the tape across the hyperbolic surface of the magnetic head. This involves control of the locations of two tape guide pins in the cartridge with respect to the aluminum cartridge base, the location of the cartridge base with respect to the molded drive base, the location of the drive base with respect to the molded head bridge, the location of the head bridge with respect to the head mount, and the location of the head mount with respect to the head surface.

Environmental tests were run, leading, for example, to a firmware change compensating for capstan behavior at cold temperatures. Life tests were conducted for every key component, accumulating such totals as 15,000 motor hours, 150,000 cartridge-into-drive insertion test cycles, and 1400 miles of head wear testing. Instruments were developed to de-



termine cartridge characteristics initially and after use. System error rate was continually tested on eleven simulated terminals. For the final error rate and terminal reliability test, 67 cartridges were interchanged among 23 terminals running on an HP 2000F Timeshared Computer System. Overall,  $2.6 \times 10^{10}$  data bytes were transferred on 6800 miles of tape with less than one error in  $10^8$  transferred data bytes.

### Acknowledgments

The authors would like to acknowledge the efforts of all those who contributed toward the success of this project. Mike Raynham designed and implemented the encoder/decoder and bus interface circuits. Paul Dugre implemented the read/write circuits, designed the automatic head tester, and was responsible for read/write head evaluation. Bill Ulrey designed and implemented the motion control and

motor drive servo circuitry and was responsible for motor evaluation and testing. Cliff Wacken designed the hole detection circuitry and helped develop the automatic cartridge testers. Curt Gowan was responsible for cartridge evaluation and system error rate testing and helped prepare this article. Frank Goodrich solved the problems of head mounting and designed independent azimuth and tilt adjustments. Larry Williams was responsible for the design of the front bezel and doors. Ed Tang developed the I/O firmware. Dave Goodreau developed the CTU diagnostics. Mark Ridenour was responsible for introducing the designs into production. Our special thanks to Ed Muns and Alan Richards of the Calculator Products Division whose cooperative efforts on the cartridge evaluation were vital. Our thanks also to Dick Monnier, Bob Colpitts, Jim Doub, and Jack Noonan for their invaluable encouragement and guidance. 



#### Richard L. Smith

Rich Smith was project manager for the cartridge tape system in the 2644A Terminal. A magnetic recording specialist since 1962, when he received his BS degree in electronics and physics from the University of San Francisco, Rich has been with HP since 1970. Three HP tape recorders owe all or part of their designs to him. Away from the job, he enjoys camping, fishing, stamp collecting, and searching for his own personal "holy grail", the perfect

full-range electrostatic speaker system design. A native of San Mateo, California, Rich now lives in San Jose. He and his wife have four children ranging in age from five to 14.



#### Louis A. Witkin

Denver Colorado native Lou Witkin came to HP in 1972, having just received his MSEE degree, and a year earlier his BSEE degree, from the University of Denver. He designed the cartridge tape and user interface firmware for the 2644A Terminal. Lou's involvement with computers began in high school, and his services as a software consultant were much in demand during his college years. He's also taught courses in logic design and control theory. Now

settled in San Jose, California, Lou is married, has two children, and occupies some of his spare time with tennis, photography, backgammon, and working for his MBA degree.

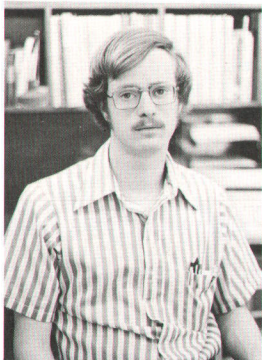

#### Alan J. Richards

Alan Richards was project leader for the cartridge tape system in the 9825A Calculator, including cartridge, drive, and electronics. As part of that project, he worked with 3M Company on the development of the new DC-100 Mini-Cartridge. He's been with HP since 1969, and had previously designed the 9865A Cassette Memory, a calculator peripheral. Alan was born in Denver, Colorado. He received his BSEE degree from Colorado State University in 1968 and his MS in computer engineering from Stanford University in 1973. He and his wife and son now live in Loveland, Colorado, where Alan is helping to establish a crisis telephone service. For recreation, he likes skiing (cross-country, downhill, and water), backpacking, camping, bicycling, and photography.



#### Robert G. Nordman

Bob Nordman designed the cartridge tape drive assembly for the 2644A Terminal. Born in New York City, he received his BSME degree from Massachusetts Institute of Technology in 1951, then served two years as a U.S. Air Force officer and spent another year studying in France and sailing the Mediterranean before settling down to a 22-year design career that's been interrupted only once more—to sail the Mediterranean again with his wife in

1957. Bob has specialized in tape drive design and holds three patents in that area. He's been with HP since 1969. Now living in Palo Alto, California, he enjoys gardening, backpacking, and playing guitar. He and his wife have three sons.



## SPECIFICATIONS

### HP Model 2644A Terminal

#### General

**SCREEN SIZE:** 5 in (127 mm) × 10 in (254 mm)  
**SCREEN CAPACITY:** 24 lines × 80 columns (1,920 characters)  
**CHARACTER GENERATION:** 7 × 9 enhanced dot matrix; 9 × 15 dot character cell; non-interlaced raster scan  
**CHARACTER SIZE:** .097 in (2.46 mm) × .125 in (3.175 mm)  
**CHARACTER SET:** 64 upper-case Roman  
**CURSOR:** Blinking-Underline  
**DISPLAY MODES:** White on Black; Black on White (Inverse Video)  
**REFRESH RATE:** 60 Hz (50 Hz optional)  
**TUBE PHOSPHOR:** P4  
**IMPLOSION PROTECTION:** Bonded implosion panel  
**MEMORY:** MOS; ROM (control memory)—12K bytes; RAM (user memory)—4096 bytes  
**KEYBOARD:** Full ASCII Code Keyboard, 8 special function keys, and 16 additional control and editing keys; ten-key numeric pad; cursor pad, multi-speed auto-repeat; N-key roll-over; detachable on a 4 foot cable  
**CARTRIDGE TAPE:** two mechanisms  
 READ/WRITE: 10 ips  
 SEARCH/REWIND SPEED: 60 ips  
 RECORDING: 800 bpi  
**MINI-CARTRIDGE:** HP part no. 9162-0061  
 110 kilobyte capacity (maximum) per cartridge

#### Data Communications

**DATA RATE:**  
 ASCII MODE: 110, 150, 300, 1200, 2400 baud, and external source—switch selectable. (110 baud selects 2 stop bits.)  
 FAST BINARY READ: 9600 baud output from terminal  
**COMMUNICATIONS INTERFACE:** EIA standard RS232C; 103-type and 202-type modem compatible  
**TRANSMISSION MODES:** Full or half duplex, asynchronous  
**OPERATING MODES:** On-line; Off-line; Character or Block Mode  
**PARITY:** Switch selectable; Even, Odd or None

#### Power Requirements

**INPUT VOLTAGE:** 115V (+10%, -23%) at 60 Hz  
 230V (+10%, -23%) at 50 Hz  
**POWER CONSUMPTION:** 85W to 125W max.

#### Environmental Conditions

**TEMPERATURE** (Free Space Ambient):  
 NON-OPERATING: -10 to +65°C (-15 to +150°F)  
 OPERATING: 5 to +40°C (+41 to 104°F)  
**HUMIDITY:** 20 to 80% (non-condensing)  
**HEAT DISSIPATION:** 483 BTU/hour  
**ALTITUDE:**  
 NON-OPERATING: Sea level to 25,000 feet (7620 meters)  
 OPERATING: Sea level to 15,000 feet (4572 meters)  
**VIBRATION AND SHOCK** (Type tested to qualify for normal shipping and handling):  
 VIBRATION: .010 in (25 mm) pp, 10 to 55 Hz, 3 axis  
 SHOCK: 30g, 11 ms, 1/2 sine

#### Physical Specifications

**DISPLAY MONITOR WEIGHT:** 44.1 pounds (20.0 kg)  
**KEYBOARD WEIGHT:** 7 pounds (3.2 kg)  
**DISPLAY MONITOR DIMENSIONS:** 17.5 in W × 18 in D × 13.5 in H (445 mmW × 457 mmD × 343 mmH) (including Keyboard: 25.5 in D (648 mmD))  
**KEYBOARD DIMENSIONS:** 17.5 in W × 8.5 in D × 3.5 in H (445 mmW × 216 mmD × 89 mmH)  
**PRICE IN U.S.A.:** \$5000.  
**MANUFACTURING DIVISION:** DATA TERMINALS DIVISION  
 11000 Wolfe Road  
 Cupertino, California 95014 U.S.A.

Laboratory Notebook (continued from page 16)

zero. This process repeats until the selected time interval elapses, terminating the count. The contents of the y counter are then equal to the logarithm of the count in x.

By making K a negative power of 2,  $\Delta x$  is easily derived by shifting the contents of a register containing the binary equivalent of x or, as shown here, by simply transferring the most significant bits in the x counter to the least significant bits in the  $\Delta x$  counter.

During operation, counting proceeds for the selected time interval, at the end of which the contents of the y counter are outputted and all counters are reset for the next counting cycle. This raises a problem, however, because  $\log 0 = -\infty$ , hardly a practical number to set into the y counter. This difficulty is overcome by selecting the point  $x_0$  for which  $y = 0$  (Fig. 1), and leaving the y counter clear until the x count reaches that point. This places a constraint on the minimum number for which the conversion is valid but this causes no problem because the upper end of the scale can be extended

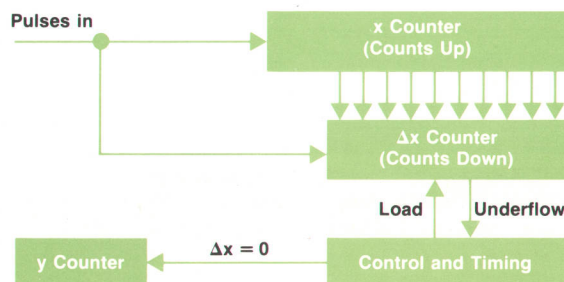

Fig. 2

as far as necessary to give the range desired.

#### Sources of Errors

$\Delta y$  can be made arbitrarily small to reduce quantizing errors to negligible proportions. The only other source of errors comes from the loading of  $Kx$  into the  $\Delta x$  counter. Since division is accomplished by truncating the least significant bits, this does not represent an exact division. The errors caused can be minimized by making the values of  $\Delta x$  as large as possible. As a result, the number in the y counter is several orders of magnitude smaller than the number in the x counter. The error can be further reduced by making  $x_0$  slightly smaller, since analysis has shown that this circuit always gives a result slightly larger than the true logarithm.

This system is used in the Model 3745A Selective Level Measuring Set (Hewlett-Packard Journal, January 1976). As applied there, it uses a VCO that operates over a frequency range of 0.1 to 1 MHz. The x counter has 20 binary stages with the 10 most significant bits transferred to the  $\Delta x$  counter, which makes K equal to  $1/1024$ . To get an answer with three-digit resolution,  $10^5$  to  $10^6$  pulses are counted, and this takes about 800 ms in the LONG AVERAGING mode. In the SHORT AVERAGING mode, the division ratio is changed and the counting period is 100 ms.

It is worth pointing out that in systems where a logarithmic amplifier is first in the chain, a bias error must be compensated for because the average of a log is not identical to the log of the average. No such error occurs in the system described here.

David Arnold  
 Hewlett-Packard Limited  
 South Queensferry, Scotland



# Laboratory Notebook

## A Logarithmic Counter

Many measurement situations require that three operations be performed on a signal:

- (1) Measure the signal's average value;
- (2) Find the logarithm of that value;
- (3) Convert the logarithm to digital form for display.

An example is a power meter where signal power is measured by a thermopile over a given time interval, and the result is displayed digitally in decibels.

When averaging, conversion to decibels and analog-to-digital conversion are performed by three independent circuits in series, each contributes its own errors and each requires calibration. It is often desirable to place the logarithmic conversion first so that measurements may be performed over a wide dynamic range, but if the analog-to-digital conversion can be placed first, then the other operations may be performed digitally and only the A-to-D converter needs to be calibrated.

A new way of implementing such a scheme uses a voltage-controlled oscillator to drive a logarithmic counter. The dc level of the signal being measured is applied to the VCO so the counter's output is a digital number proportional to the logarithm of the measured voltage averaged over the counting interval.

### Counting Logarithmically

The key to this scheme is the logarithmic counter. In the curve,  $y = \log x$ , in Fig. 1,  $x$  represents the number of pulses fed into the counter from the VCO and  $y$  is the corresponding counter output. Since the counter output is digital, the output is quantized into equal increments  $\Delta y$ . The corresponding increments  $\Delta x$ , however, vary according to the instantaneous value of  $x$ .

Consider the point  $y' = \log x'$ . To increment  $y'$ , the following relationship must be obeyed.

$$y' + \Delta y = \log(x' + \Delta x') = \log x' + \log(1 + \Delta x'/x')$$

Therefore:  $\Delta y = \log(1 + \Delta x'/x')$

Since  $\Delta y$  is a constant,  $\Delta x/x$  is constant for all values of  $x$ . Thus,  $\Delta x = Kx$ , where  $K$  is an arbitrary constant. Since  $K$  will be less than one,  $\Delta x$  may be found for every value of  $x$  by division.

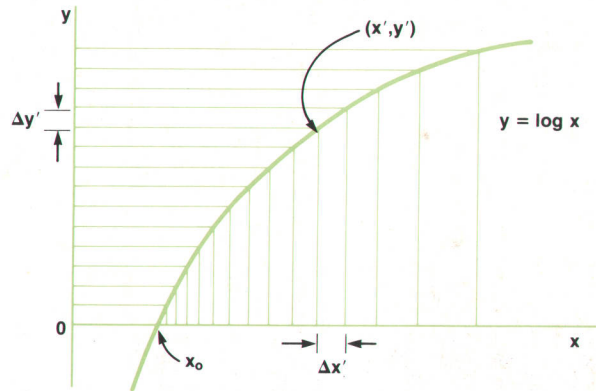

Fig. 1

A method for implementing the logarithmic counter is shown in Fig. 2 (page 15). Here, the output of the VCO is fed to both the  $x$  and  $\Delta x$  counters. The  $x$  counter is a straightforward up counter whereas  $\Delta$  is a presettable down counter.

Whenever the count in  $\Delta x$  goes to zero, the  $y$  counter is incremented. A number equivalent to  $Kx$  is then loaded into the  $\Delta x$  counter and counting continues until  $\Delta x$  again goes to

(Continued inside on page 15.)

Hewlett-Packard Company, 1501 Page Mill Road, Palo Alto, California 94304

### HEWLETT-PACKARD JOURNAL

MAY 1976 Volume 27 • Number 9

Technical Information from the Laboratories of Hewlett-Packard Company

Hewlett-Packard S.A., CH-1217 Meyrin 2  
Geneva, Switzerland  
Yokogawa-Hewlett-Packard Ltd., Shibuya-Ku  
Tokyo 151 Japan

Editorial Director • Howard L. Roberts  
Managing Editor • Richard P. Dolan  
Art Director, Photographer • Arvid A. Danielson  
Illustrator • Sue M. Perez  
Administrative Services, Typography • Anne S. LoPresti  
European Production Manager • Michel Foglia

Bulk Rate  
U.S. Postage  
Paid  
Hewlett-Packard  
Company

325757AAAA128MCANAAA 193

MR M L MCANNALLY  
BOX # 12826  
PENSACOLA

FL 32575

**CHANGE OF ADDRESS** To change your address or delete your name from our mailing list please send us your old address label (it peels off). Send changes to Hewlett-Packard Journal, 1501 Page Mill Road, Palo Alto, California 94304 U.S.A. Allow 60 days.